



FEATURES

- Efficient e-volute design for better performance and Energy efficiency
- Seal less magnetic drive coupling
- Max Temp: PP 80° - ECTFE 98°C
- Interchangeable Port fittings:
 - Socket union for rigid piping connection with PP, PVC, PVDF union ends choice
 - hose barb for hose connections
 - flanged
 - BSP threaded

APPLICATION FIELDS

- Acid and alkaline solutions with minimal solid suspended particles
- Electroplating, Chemical and PCB industry

ADVANTAGES

- Enhanced Safety
- Some Dry-Run capability with carbon impeller bearing
- Energy saving
- No metal contact with pumped fluid.
- Low maintenance, easy to repair due to limited number of components

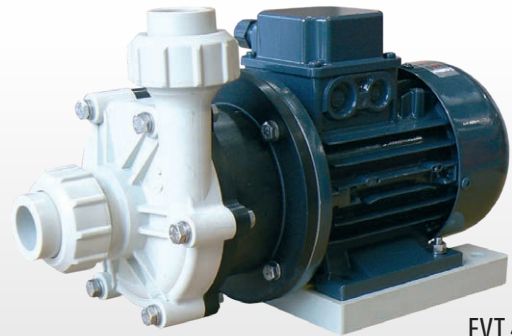

EVT 4-7

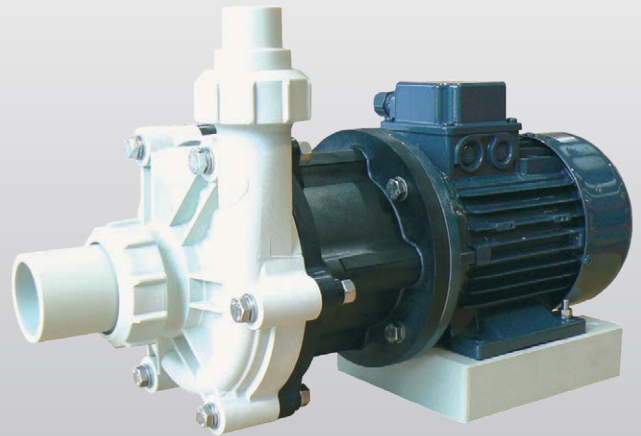

EVT 12-20

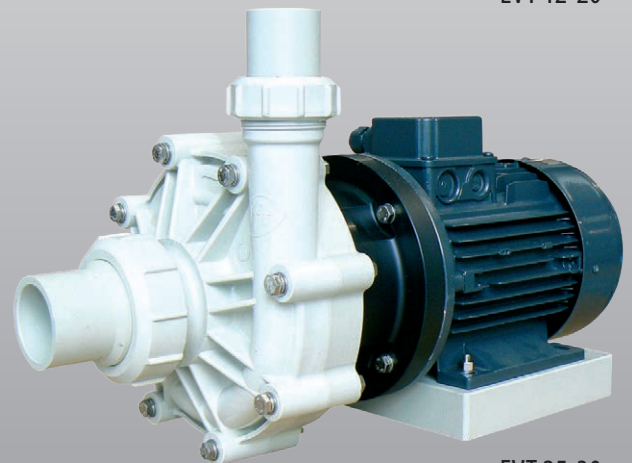

EVT 25-30

	Flow Rate max (l/min.)	Head max (m)	Motor	
			(kw)	(HZ)
EVT 4	57 ⁽¹⁾	8,0 ⁽¹⁾	0,12	50
	80 ⁽²⁾	7,3 ⁽²⁾		60
	58	9		
EVT 7	112	11	0,25	50
	121	12	0,37	60
EVT 12	200	12	0,55	50
	210	13		60
EVT 15	270	15	0,70	50
	275	17		60
EVT 20	320	16	1,10	50
	350	20		60
EVT 25	400	21	1,50	50
	420			60
EVT 30	520	28	2,20	50
				60

⁽¹⁾D IN/OUT=25mm ⁽²⁾D IN/OUT=32mm

PUMP IDENTIFICATION								
Model	Pump body	Impeller	Shaft	Impeller bearing	O-Ring	Connections		Motor / rpm
						Type	Material	
EVT 4 EVT 7 EVT 12 EVT 15 EVT 20 EVT 25 EVT 30	P = PP F = PVDF E = ECTFE*	P = PP F = PVDF E = ECTFE	C = Ceramic S = SIC	T = PTFE G = Carbon C = Ceramic R = Rulon	E = EPDM V = Viton	B = Socket union F = Flanged P = Hosebarb T = BSP Threaded	P = PP F = PVDF C = PVC	A = 50 Hz / 2800 B = 60 Hz / 3400
EVT 12	P	P	C	G	E	B	F	A

* Only EVT4

Whilst Dry-Run is not recommended, EVT Pumps have some Dry-Run capability when equipped with Carbon bearings

Performance Curve 50 Hz - Rpm 2800

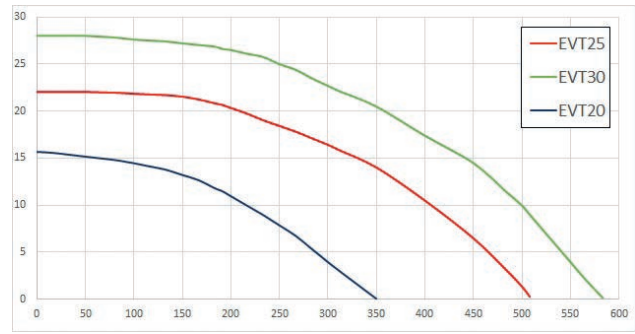
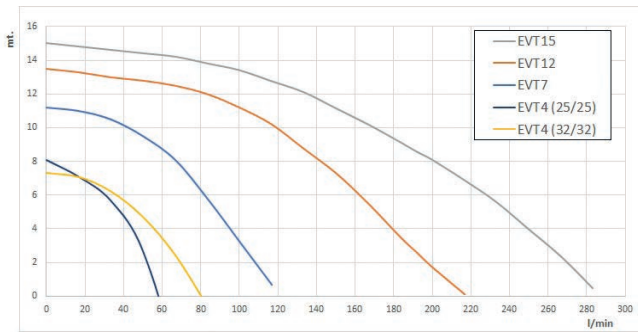

Performance Curve 60 Hz - Rpm 3400

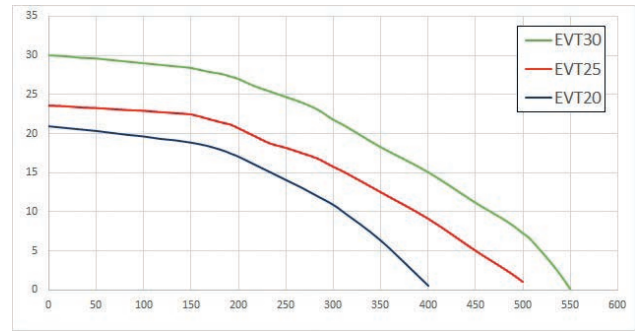
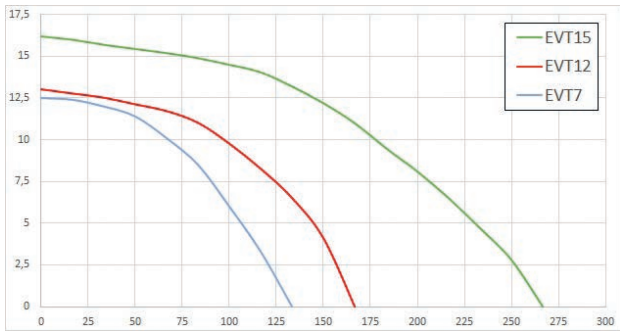

Curves referred to water=20°C

CONNECTION TYPE B - T

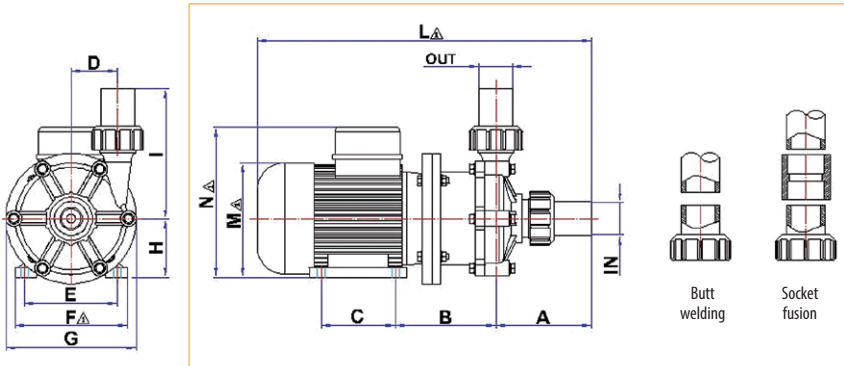

CONNECTION TYPE P

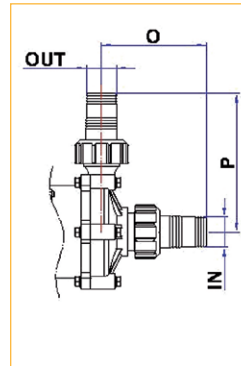

CONNECTION TYPE F

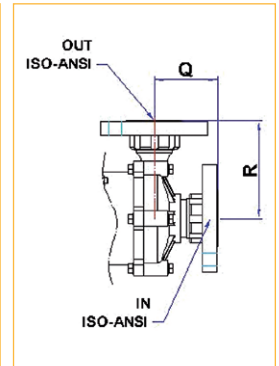

Dimensioni:

Mod.	A	B	C	D	E	F Δ	G	H	I	L Δ	M Δ	N Δ	O	P	Q	R	IN	OUT
EVT4	68,5	103,0	71	35	90	112	110	56	105	304	110	150	90,5	127	53,5	90	25	25
EVT7	88,0	108,5	80	50	100	120	140	63	125	345	120	162	113,0	150	68,0	105	32	32
EVT12	108,0	174,0	90	65	112	136	195	71	155	446	137	170	153,0	200	67,0	125	50	32
EVT15	108,0	174,0	90	65	112	136	195	71	155	446	137	170	153,0	210	67,0	125	50	40
EVT20	108,0	179,0	100	65	125	160	200	80	155	475	156	210	153,0	210	67,0	125	50	40
EVT25	144,0	198,0	100	84	140	170	246	90	201	551	176	220	175,0	236	86,0	160	63	40/50*
EVT30	144,0	198,0	125	84	140	170	246	90	201	567	176	220	175,0	246	86,0	160	63	50

Δ Value could change according to motor brand

* Flanged Version

LAFONTE.EU may modify data any time, without notice, in order to get product enhancement